

Preparation:

Read the mounting instructions carefully and make sure that all the parts are included as per the list. Turn off the engine and disconnect the battery when working on the electrical system. Remove the Barkbusters plastic guards from the bike. **Tools Required:** 4mm drill bit, 8mm drill bit and Phillips Head screwdriver.

LED Light Installation:

VERY IMPORTANT: FOLLOW ALL INSTRUCTIONS CAREFULLY TO ENSURE A CORRECT FIT.

The LED Position Lights can be mounted on the upper or lower face of the **VPS** and **STORM** plastic guards. The LED Position Lights can be mounted on the upper face only of the **JET** plastic guards. This allows the LED Indicators to be combined with the LED Position Lights. (LED Indicators sold separately. Code: **LED-001-00-AM**)

1. Enclosed is a paper Drilling Template to locate and drill the light mounting holes in the plastic guards. **IMPORTANT: CAREFULLY** cut out the appropriate template **perfectly** along the line.
2. Place the template on the **REAR** of the guard as per examples below and secure with clear tape. Using a scribe or centre punch apply pressure by hand to mark the centre of the three holes per template to be drilled. **Important:** When marking the drill holes place plastic guard on a cloth or soft surface to avoid damaging the front face.
3. Remove the template and drill through all the 3 holes with a **4mm** drill bit. Then enlarge the middle hole for the wires with an **8mm** drill bit. Remove any plastic burrs from around the holes. **Important:** When drilling holes hold plastic guard in hand to avoid damaging front face, do not rest on a hard surface. Take care not to drill into your hand.



NOTE: Photos indicate correct placement of Drilling Templates on **REAR** of guard. Secure with clear tape prior to drilling.

4. Thread the LED wires (1) through the **8mm** hole and fit the backing plate (2) in position. Position the LED wires (1) under the backing plate (2) and ensure they exit at the cutout towards the inside of the guard.
5. Insert the screws (3) through the backing plate (2), through the front face of the guard and locate them in the screw holes of the LED light (1). Tighten screws (3) being careful not to over tighten.
6. Re-fit the plastic guard to the Barkbusters aluminium backbone.
7. Run the wires along the aluminium backbone to original motorcycle cabling and secure with supplied cable ties.

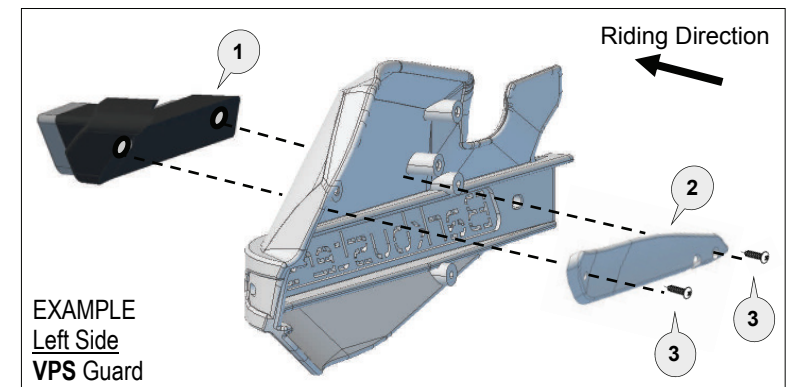

IMAGE: Left VPS guard with LED being mounted to upper face of guard.

Connecting to Electrical System:

Connect the YELLOW and BLACK wires from the left and right LED Position Lights to the Joining Wire (5). Make sure wire colours match in the connection plugs.

Connection Options Note: some countries require Position Lights to only operate when instrument lights operate. For this situation we recommend **Option B**.

Option (A)

1. Check your bike for an available ignition powered auxiliary plug and a negative plug. If not available use connection option B.
2. Check plugs are compatible with the male plugs supplied with Joining Wire (5).
3. Take the Joining Wire (5) and strip off the pre-cut outer insulation from the end of the YELLOW & BLACK wires.
4. Attach the supplied male plugs along with the clear insulation covers.
5. Connect male connectors into auxiliary female plugs on your motorcycle making sure you connect YELLOW to **Positive** and BLACK to **Negative** (ground).
6. Power up motorcycle and check LED Position Lights are functioning correctly and that LED's turn off when ignition is turned off.

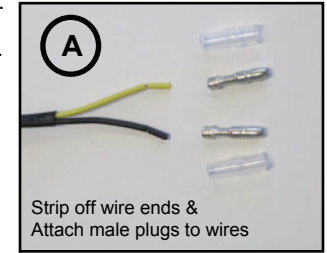

Option (B) - with JOW T-Connectors (6)

1. Cut off the ends of the YELLOW and BLACK joining wire (5) completely at the pre-cut section (approx. 7mm from the end). *Note: The JOW T-Connectors DO NOT require bare wires to make an electrical connection.*
2. Insert wire into straight end of JOW T-Connector (6) and press closed. *Note: Pliers may be required.* Do this on both YELLOW and BLACK wires.
3. Locate a Headlight or Dash/Instrument light **Positive** wire and a **Negative** (ground) wire.
4. Attach T-end of the JOW T-Connector (6) with YELLOW wire to the **Positive** wire in an appropriate place and press closed.
5. Attach T-end of the JOW T-Connector (6) with BLACK wire to suitable **Negative** (ground) wire and press closed. Power up motorcycle and check LED Position Lights are functioning correctly and that LED's turn off when Dash/Instrument lights are turned off.

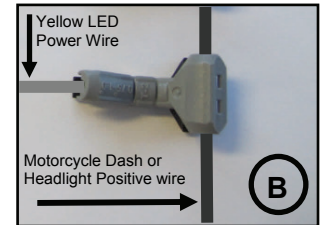

Attention:

Cover any bare wires or connections with electrical tape or heat shrink. Make a final check by operating the steering from lock to lock and check that all cables and wiring are not under tension or scrape or rest against any hot or moving parts. Ensure that all moving parts are not hindered in any way. After installation ensure that all previously removed parts are reinstalled correctly. Before riding perform a comprehensive check of all functions of the motorcycle. If any problems are detected do not ride the motorcycle until they have been rectified.

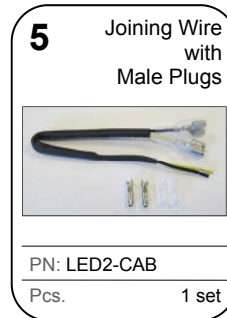
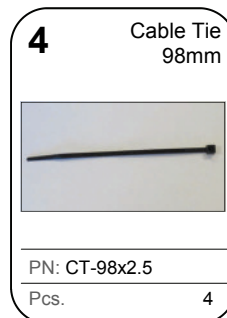
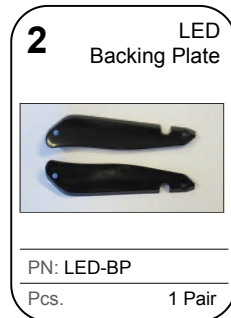

Phone: +61 (0)2 4271 8244
Email: info@barkbusters.net
Web: www.barkbusters.net

Barkbusters

IMPORTANT:

Observe any laws and regulations specific to your state and country. Obtain appropriate authorisation where necessary. *The LED Indicator lights and Position lights are E mark approved.*

CAUTION:

Installation of the LED lights is safety-relevant work and can be complicated. We recommend the installation be performed by a motorcycle service technician. Rideworx accepts no liability for damages caused by improper mounting. Be careful not to over tighten the four 3.5mm fixing screws as they are secured into plastic. Carefully follow all the directions given in the mounting instructions. Non-conformance can lead to damage to the vehicle or risk to the rider. Before installing this product, check with your local regulatory authority to see if it complies with local vehicle standards. Check operation of all lights before use. Do not ride the motorcycle if any lights are not operating correctly. Check periodically that all screws are tight and lights are operating correctly.

Disclaimer:

A failure to follow these fitting instructions could cause serious injury, death or property damage. By installing and/or using this product you acknowledge that you accept these terms and have followed the fitting instructions.

Drilling Template for Barkbusters LED Lights

Storm Handguard Upper



Storm Handguard Lower



VPS Handguard Upper



VPS Handguard Lower



JET Handguard Upper

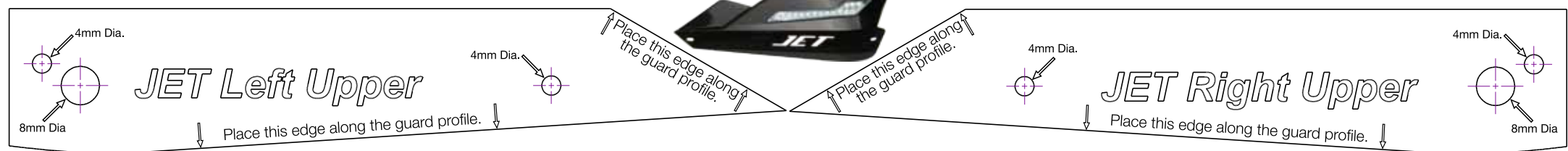

⚠ Attention: This template is included with your instructions and all parts necessary for installation. Apply individual templates to back of guard as per instruction sheet. If you have downloaded this PDF from our website ensure that you print it at 100% of size. To check, measure the scale right of this text.

